

YE-2041 15A BATTERY CLIP

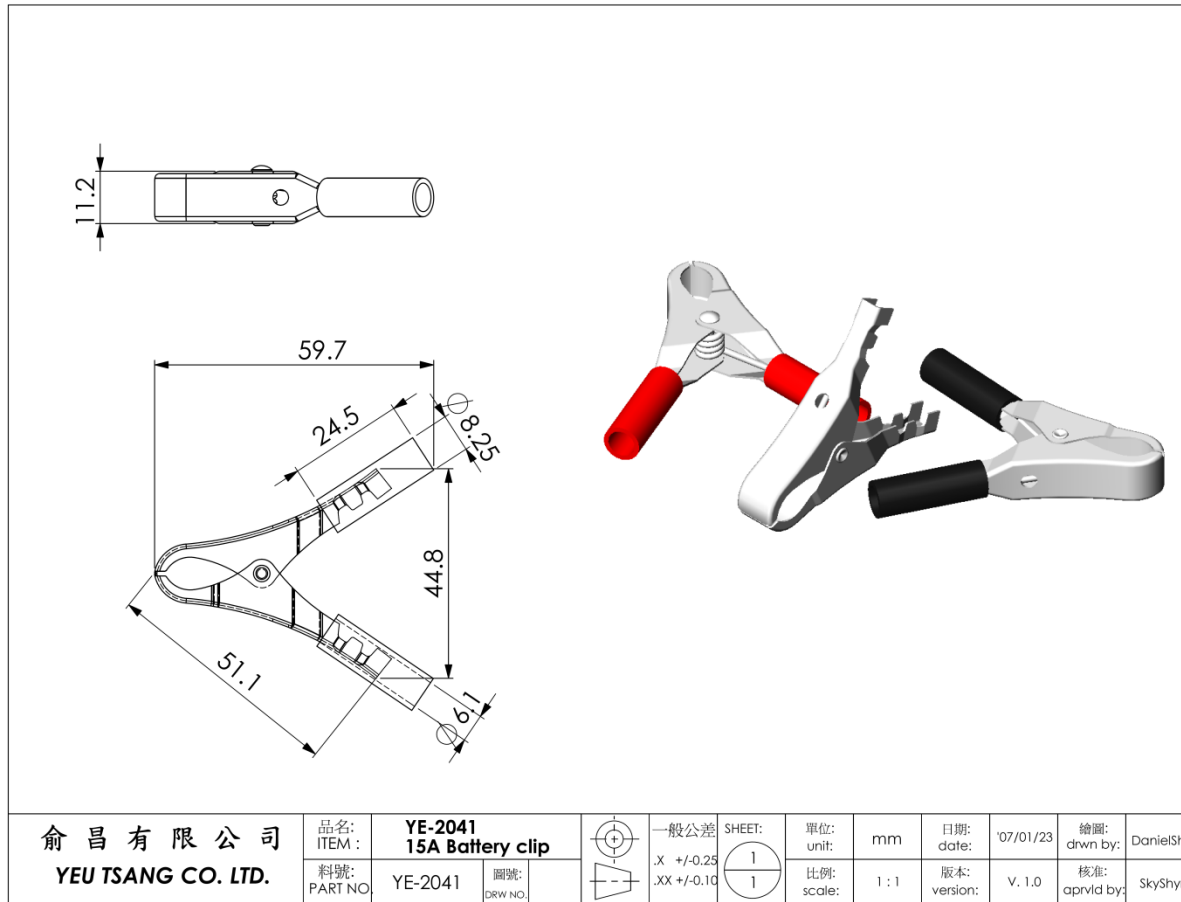

MATERIALS :

1. MAIN BODY :
STEEL NICKEL PTD.
2. SHELL COVER :
PVC
3. SPRING:
STEEL NICKEL PLATED